

8

7

6

5



4

3

2

1

D

D

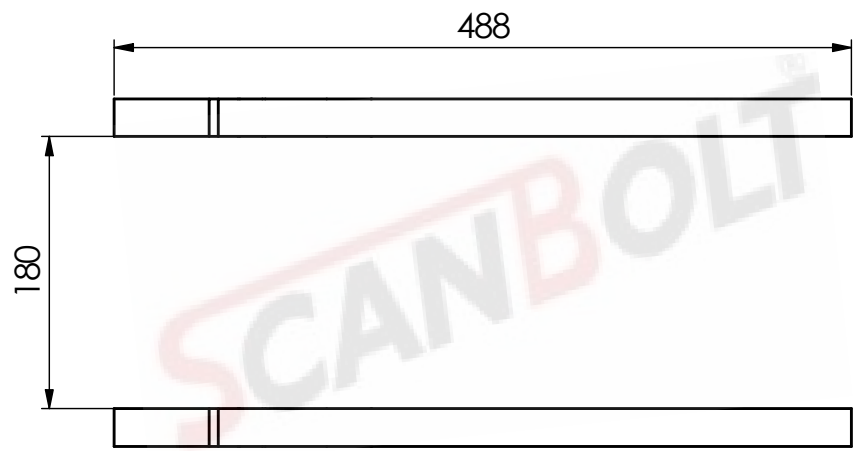
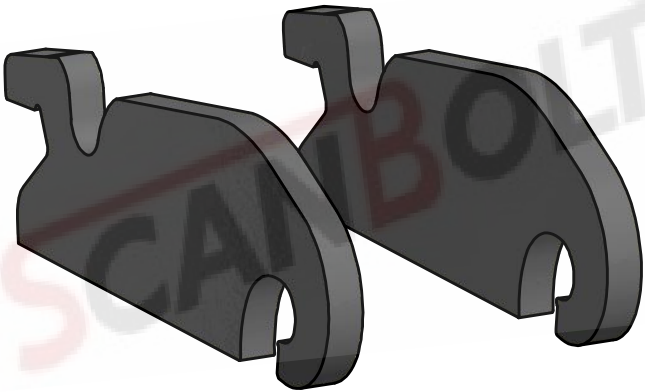

C

C





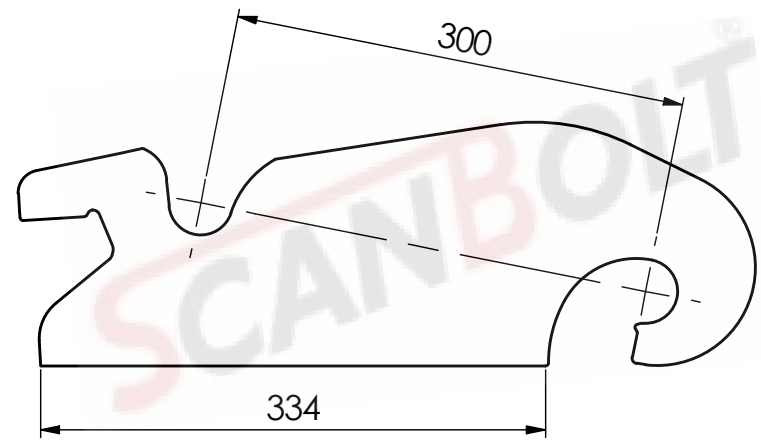
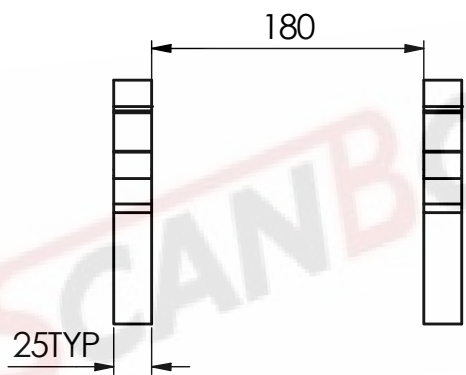

B

B



A

A

MATERIAL SPECIFICATION	
	ST52.3
	EN8D
	HB 400
	HB 450
	CASTALLOY STEEL

SCANBOLT®	
DESCRIPTION	CW10 HANGER
MACHINE CLASS	3.5-10 TON
WEIGHT	23 KG
HEAPED CAPACITY	

8

7

6

5



4

3

2

1